

THE KIMBERLEY KRUISWAGEN



2026 ACCESSORIES GUIDE

V - 110326



KIMBERLEY KAMPERS

KING OF THE OFF ROAD™

www.kimberleykampers.com.au

VEHICLE



REAR DOOR SPARE TYRE CARRIER, LADDER FRAME

- **Increased Range:** 151-litre capacity (vs. OEM 93 litres), boosting range by 62% for extended off-road travel.
 - **Seamless Fit:** Plug-and-play installation using OEM fuel lines and gauge sender, fits stock location without affecting water capacity.
 - **Durable Design:** Crafted from ¼-inch thick crosslink polyethylene, corrosion-resistant, with an Australian-backed warranty (if installed by an authorised agent).
- Accurate Fuel Gauge:** Stays on FULL longer; gauge remains reliable, though DTE may require optional software override for accuracy.
- **Lightweight Upgrade:** Only 5.1kg heavier than the OEM tank, ideal for serious off-road adventurers.
 - **Optional DTE Software:** USA-made, Australian-supported software plug-in for accurate Distance to Empty readings (sold separately).

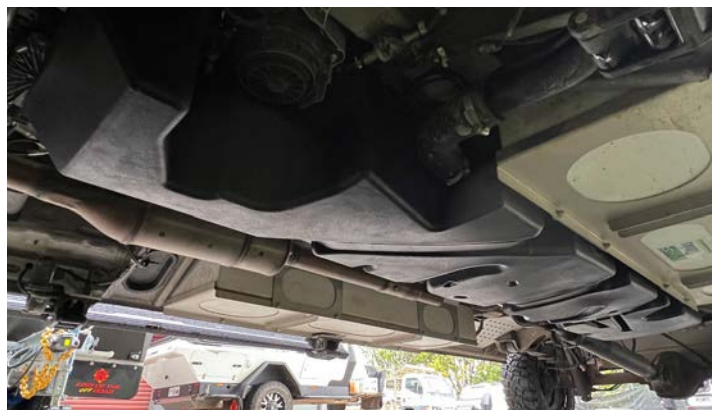

LONG RANGE FUEL TANK - Distance To Empty (DTE) Tool

Distance to Empty Calibration Tool

- There is a plug and play DTE (Distance to Empty) calibration computer for the OBD2 Port in the Mercedes Sprinter that corrects the distance to go in the internal Computer.
- This is imported from the USA and plugs into the Mercedes CANBUS system allowing a recalibration and an accurate DTE for the 151L Long Range fuel tanks.



VEHICLE



ALLOY SPORTS BAR WITH LED DRIVING LIGHT

KAG

Lightweight alloy sports bar provides some protection at the front of the vehicle but also doubles to hold the LED lightbar driving light and the UHF Aerial if optioned in.

- Large-diameter tube aluminium alloy construction
- Powder coated
- LED Driving light bar included

LED Light Bar features:

- Bright Output: 4010 lumens, 5000K, 1 lux at 586m for strong mid to long-range light.
- Smart Design: Edge-to-edge lens, 30° horizontal/15° vertical beam for optimal highway use.
- Flexible Modes: Full or reduced output, plus amber (1500K) or white (6000K) DRL options.



UNDERBODY PROTECTION: ENGINE, GEARBOX GUARD PLUS DIFF/SILL GUARDS

Giving the ultimate in underbody protection for your investment. These heavy duty aluminium guards protect your undercarriage from accidents.



VEHICLE



KK Attitude Bullbar - Max. Strength & Front-End Protection

Picture touring through the outback, a roo darting across your path.

No worries—your KK Attitude Bullbar's got you. Made from aluminium alloy with a black powder coat, it's light yet tough.

Laser-cut and interlocking, it maximizes strength without bulk. LED driving lights pierce the haze.

It guards your Ad-blue tank and radiator from strikes and rough terrain. Twin 5T recovery points handle Warn, Runva, or TJM winches.

Built for LED bars, UHF, and Mercedes tech—Lidar, camera, sensors.

Just 39kg with hardware. It's your wild-conquering wingman.

KK ATTITUDE BULLBAR

KAG

- aluminium alloy bar with black powder coat finish: strong, protective, lightweight.
- Integrated LED driving lights.
- Shields key front-end parts (Ad-blue tank, radiator) from animal strikes and off-road damage.
- Includes two 5T-rated recovery points, compatible with Warn, Runva, and TJM winches.
- Custom-designed for LED light bars, UHF aerials, Mercedes Lidar radar, front camera, and proximity sensors.
- Weight with hardware: ~39kg



WARN VR EVO 12-S Winch (103255)

KAG

- Strong: 12,000 lb capacity for heavy-duty recovery.
- Fast: Quick line speed, low amp draw.
- Durable: IP68 waterproof, weather-resistant.
- Reliable: Albright® contactor for consistent control.
- Flexible: Convertible control pack for mounting options.
- Lightweight: 90 ft synthetic rope, easy to handle.
- Convenient: 11.5 ft corded remote.
- Stylish: Sleek, tactical look.
- Warranted: Lifetime mechanical, 7-year electrical coverage.

VEHICLE



SPARE TYRE GAS BOTTLE MOUNT

KAG

Mounting on your spare tyre allows you to still run a rear bin bag. Gas Bottle sits elevated and flush with the sidewall of the tyre, ensuring it's located safely within your setup.

Secure thumb screw mounts for toolless removal of the gas bottle, whilst two sets of slots for straps provide additional securing options.

Positioned at an accessible height on the Spare Tyre.

Made from 3mm 304 Stainless Steel, powder coated in a durable textured matt black finish that will blend in with your tyre and won't rust.

Suits 1.25kg & 2kg Companion & Gasmate LPG Gas Cylinders.



ELECTRIC SIDE STEPS - ROCK SLIDERS

KAG

- Automatically deploy for easier access.
- Shield the vehicle's sides from terrain damage during off-road adventures.
- Retract for a sleek look when not in use.
- Non-slip surfaces enhance safety in wet conditions.



REAR BUMPER STEP

KAG

- Strong: 12,000 lb capacity for heavy-duty recovery.



VEHICLE



EXPEDITION ROOF RACK W/LARGE LED LIGHT BAR

KAG

- Allows for carrying more gear like kayaks, surfboard, SUPs or camping equipment.
- Utilizes unused roof space, keeping the interior less cluttered.
- Aerodynamic Design: Designed to minimize drag, and lessen any increase in fuel consumption for a full-size roof rack.
- Made from aluminium alloy suitable for rugged travel, but with reduced weight.
- Integrated high output LED driving lightbar and corner LED camping worklights.

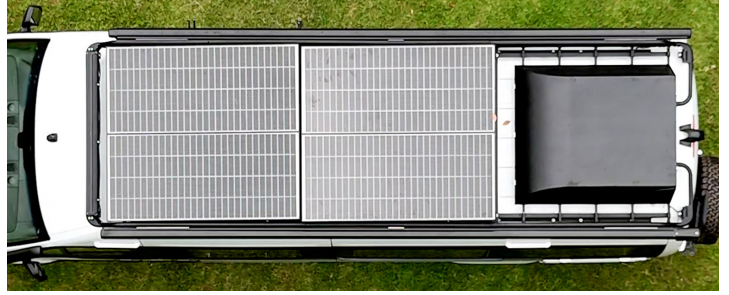
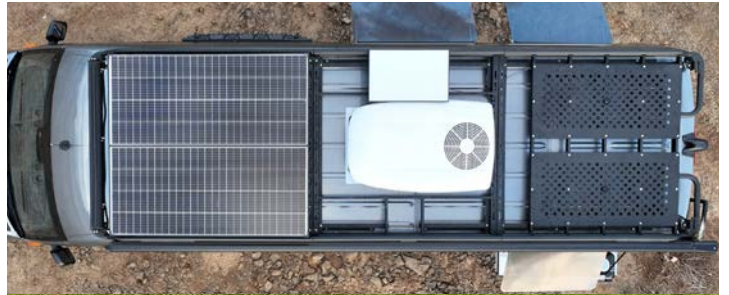

VEHICLE

AEROPOD ROOF-MOUNTED STORAGE POD

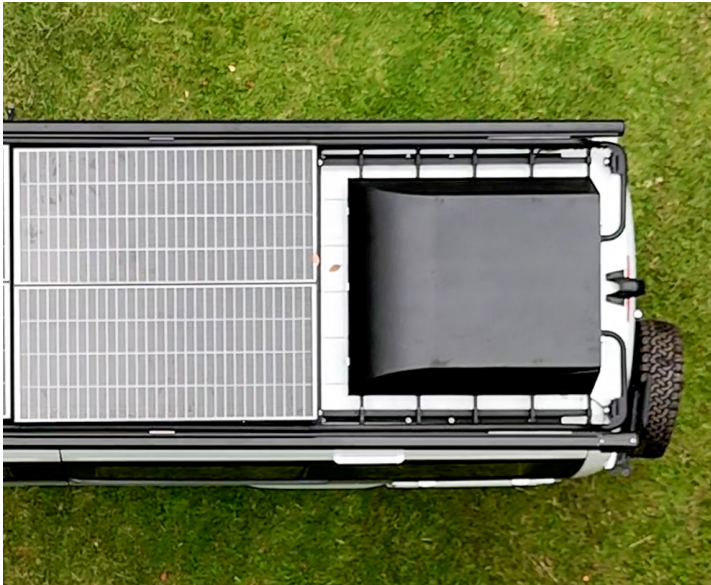

AEROPOD ROOF STORAGE POD

KAG

A roof-mounted waterproof storage pod for an offgrid motorhome offers:

- Space Saving: Utilizes unused roof space for additional storage.
- Protection: Keeps gear dry and secure from weather elements.
- Aerodynamic Design: Minimizes drag for better fuel efficiency.
- Accessibility: Easy to access without cluttering interior space.

VEHICLE

AEROPOD ROOF-MOUNTED STORAGE POD

Dimensions

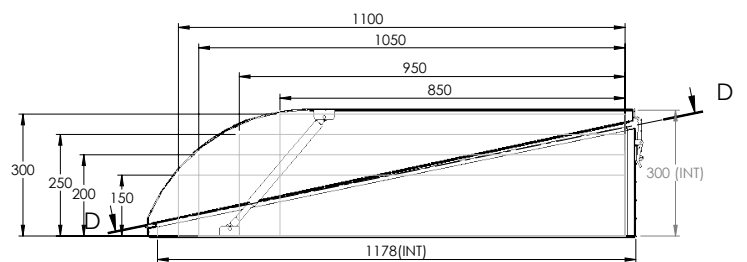
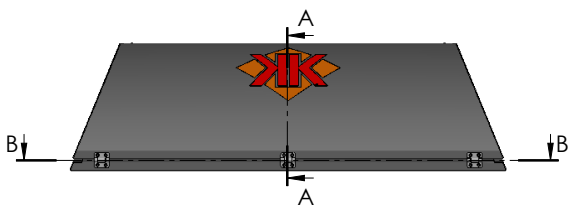
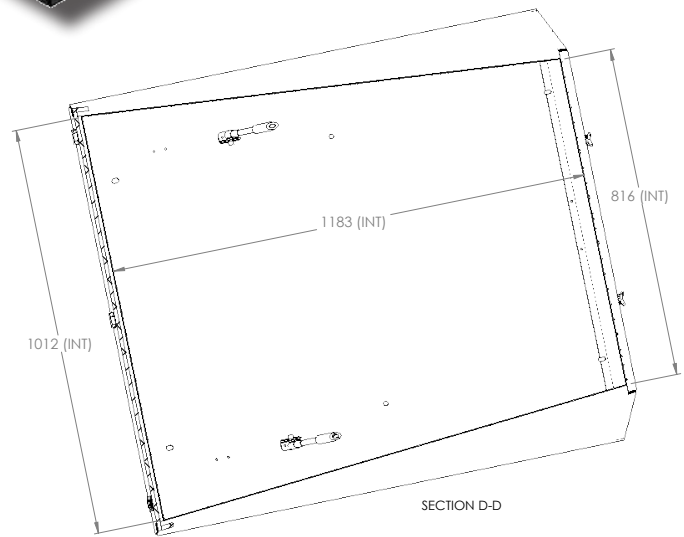

SECTION A-A

VEHICLE



SAFARI SNORKEL AIR INTAKE

KAG

Relocates the air intake to a higher position on the vehicle. Enhance the visual appeal of your Kruiswagen with these benefits;

- improved water fording capacity
- protection against dust and debris
- better quality intake - draw in cleaner, cooler air
- enhanced engine longevity

Features a 5 year warranty and is manufactured from premium EXXONMOBIL 8446.21 series high-end polyethylene offering optimal properties and toughness.



REAR DOOR SPARE TYRE CARRIER, LADDER FRAME

KAG

Lightweight ultra strong spare tyre and ladder Karrier allows convenient access to the spare tyre or doubles as a ladder for access to the rear roof rack storage area.



REAR DOOR CARGO FRAME

KAG

KK Rear Swing Away for Gear Rack frame on rear Driver Door. Lightweight Alloy.

VEHICLE

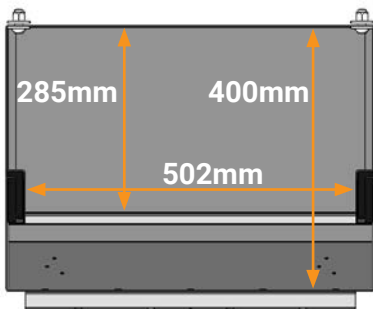

REAR DOOR CARGO FRAME STORAGE BOX - 300L

Made from lightweight alloy this box has the DNA from Kimberley's Delta Gullwing storage boxes on their Kamper range since 2007. The box including the shelves comes in at a net weight of only 24.6kg.

The vertically lifting door provides shade and cover for the contents within enabling for you to access gear stored inside the box if it is raining. This area provides shelter for both yourself and the contents.

The x2 heavy duty OJOP latches allow easy padlocking to keep the contents safe and secure.

The Delta Storage Box comes with x2 conveniently located removeable storage shelves allowing maximum use of the storage provided creating x3 potential storage decks for gear within.

Convenient Kargo Keepers allow the customer to secure in situ any gear located on the storage shelves so it does not get bounced around un-necessarily.

Easily removing the storage shelves creates a large storage area that is custom made to house x2 full adult sets of Golf Clubs. This has lashing-down straps to keep the cargo safe and secure.

The Outside rear lid has x2 deck plates on it to provide an additional accessory rack to store additional necessities like an axe and/or shovel or another set of Maxtrax or anything else that needs to be stored externally.

This storage box has a recommended carrying weight of 25kgs

Dimensions:

Approx. Height x Width x Depth – 1250mm x 560mm x 430mm

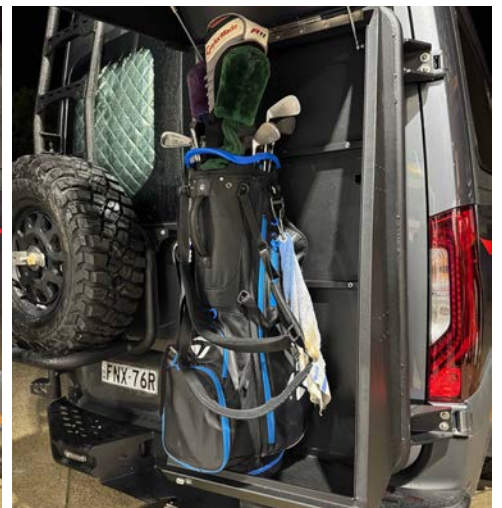

VEHICLE

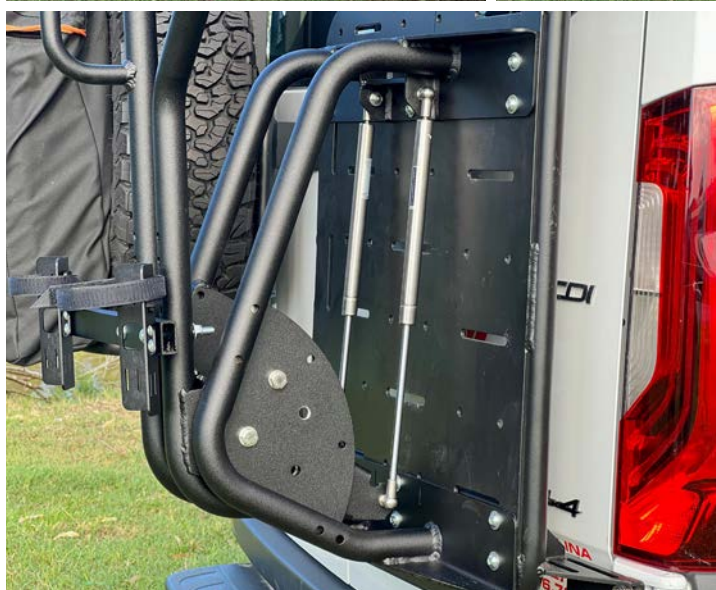

REAR DOOR E-BICYCLE CARRIER

KAG

Can accommodate x2 bikes in a vertical orientation and swings down for easy loading and unloading.

- Utilizes the Kimberley back rack for installation.
- Gas strut-assist to take away the strain of loading heavy e-Bikes.
- The rack is robust yet lightweight, reducing strain on the van's door. It comes with a powder-coated black finish, which not only looks good but also adds to its durability against environmental wear.
- Bike Security: Chain your bikes to the rack using the built-in security loop.
- Frees up interior space.
- Modular mounting allows for easy removal and reconfiguration of rear back rack with storage box etc.

VEHICLE



REAR DOOR GAS BOTTLE HOLDER (2kg)

KAG

Conveniently located on the rear door.

Great security flip-over design encases gas bottle and secures with padlock.

Provides easy access to the galley for any gas appliances or BBQ's.



4X CORNER LED WORKLIGHTS WITH CENTRAL SWITCHING

KAG

x4 ultra bright 360° surround worklights.

Turned on and off remotely via App or by switch, these provide a bright area around your campsite being positioned facing outward at 45° on all x4 corners of the Kruiswagen.

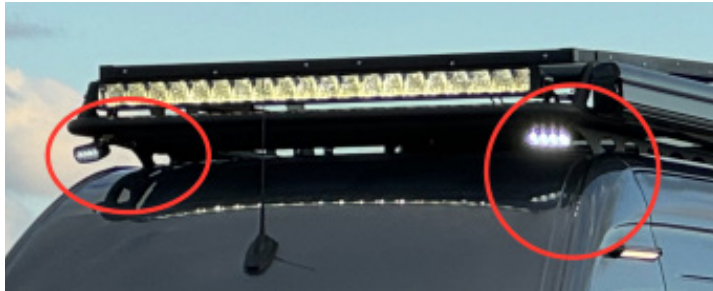

VEHICLE

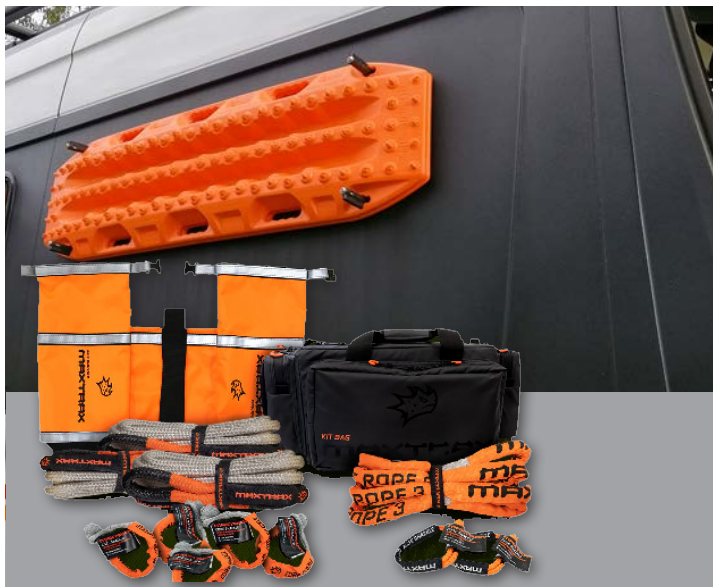

MAXTRAX PREMIUM RECOVERY GEAR KIT

KAG

This kit is essential if you have tougher trails and offroading in mind, especially when the space to recover is minimal. Utilise the provided shackles, ropes and rope dampener to successfully get moving again.

This 'Bush Kit' is geared for bush tracks - where you don't always have much room to play with. Each kit contains a variety of rope lengths - connect them with core shackles to lengthen them according to how much space you have.

- Contains the essentials to recover you for bush 4wding.
- Packs neatly into Maxtrax Recovery Kit Bag made from 600D Polyester with PVC Coating, Polyester Lining to protect your gear.



TOWBAR PACK & ELECTRICS

KAG

With a convenient located, high positioned tow hitch, you can tow up to 1750kg with a drawbar weight of up to 175kg

ADR approved and includes:

- Ball mount
- Pin and clip
- Stainless steel cover plate
- Bolt kit
- 50mm Chrome tow ball
- Wiring loom
- D-Shackles
- Life time warranty



UHF UNIDEN FITTED WITH HIGHGAIN ANTENNA

KAG

Mini Compact Size UHF CB Mobile – 80 Channels with Remote Speaker MIC, Large LCD Screen with Masterscan™ and ATS450 Antenna. The latest in UHF communication from the world leaders in wireless communication.

The X66 is extremely compact, yet so versatile and full of features and is now equipped with Masterscan Technology.

The X66 is built for rugged Australian and New Zealand conditions, making it ideal for the truck drivers, 4WD Drivers and Caravan Drivers. Uniden's reliability and experience in UHF makes this unit ideal for the professional who needs to keep in touch with the outside world.

The X66 offers the finest components, engineering and styling.

AWNING & CANVAS



2.2 X 4.5M ROLL OUT AWNING

KAG

The 4.5m roll out awning is compact and durable. It features easy setup, a robust aluminum case and UV-resistant fabric. Perfect for extended outdoor living space with minimal effort.

Supplied with manual wind out or upgraded with electric motor for one-touch set up.



KRUISWAGEN BEDOUIN EXTENSION FOR AWNING

KAG

Add a Bedouin Awning Extension for more shade and privacy.

Set up is easy - just slide into the awning edge and peg out the corners.

- Super quick to set up - zip-on, peg-out
- Integrated tension straps
- Add privacy and shade



KRUISWAGEN VINYL DRAFT SKIRT

KAG

- Add a vinyl draft skirt to fully enclose your outdoor living space.
- Blocks wind and helps keep out the bugs.
- Fits to the contours of vehicle for snug fit.

AWNING & CANVAS



KRUISWAGEN CANVAS MESH WALLS WITH ANTI-FLAP KIT

KAG

Everything you need to create a comfortable and private outdoor 'alfresco' living space. Perfect for hosting happy hour or just to cook outside with improved protection from nasty weather.

Three roll-up windows with insect screening allow for great airflow and easy access. 3-Peice Modular design allows for flexible Wall set ups to suit the season.

- Front/Side/Rear Walls - Front, Side & Rear Walls Hanger Strips
- Draft Skirt and Press Studs for mounting Draught Skirt
- Front & Rear Wall Body Infills with Sail Track for mounting
- Fiamma Fast Clip Wall Hangers - Left & Right
- Fiamma Tension Rafter PRO (curved)



3.2M FIAMMA BAG AWNING - DRIVERS SIDE WITH SAILTRACK

KAG

The easy to use, sturdy and lightweight bag awning with manual operation plus tubular rewind for wrinkle-free fabric.

- Easy to extend for shade or shelter.
- Adds outdoor living space for relaxation or storage.
- Shields from sun, light rain, and wind.

(Note this image shows awning on a Karavan).

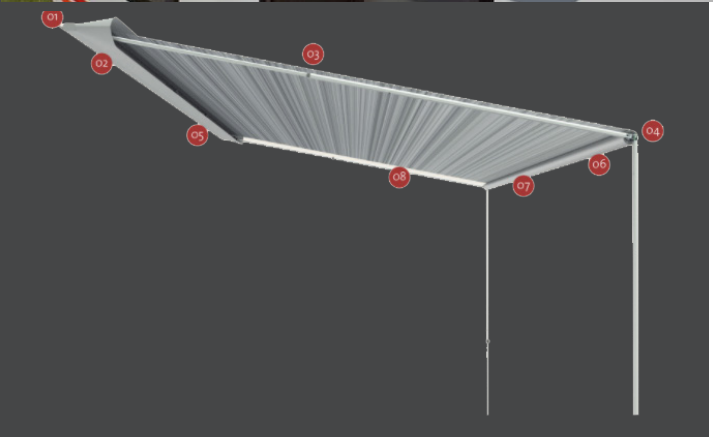

2.2 X 4.5M ROLL OUT AWNING - DRIVER SIDE

KAG

Add a second awning on the driver side for even more space and shade.

- Easy to extend for shade or shelter.
- Adds outdoor living space for relaxation or storage.
- Shields from sun, light rain, and wind.



COMFORT



FULL-HEIGHT ENSUITE WITH SHOWER

KAG

A modern and space efficient ensuite with shower space and a composting toilet.

Floor, ceiling, rear and side walls are one-piece composite construction. With only one seam around front wall for excellent leak prevention.

Full height door with translucent glass provides privacy but creates light and airy feel to make ensuite feel bigger. Integrated extraction fan and door gap help control moisture/steam build up when showering.

Composite materials are known for their strength and resistance to wear and tear, moisture, and mould.



OUTSIDE HOT AND COLD SHOWER - WITH VISI FLOW SYSTEM

KAG

Outside hot and cold shower on drivers side with Visi-Flow AUX water source - allows pumping from streams and jerry cans.

AUX inlet also provides quick fill pressure filling system for easy water tank filling.



WATERLESS COMPOSTING TOILET

KAG

- Since it doesn't require water to operate, it significantly reduces water usage.
- It minimizes the environmental footprint by composting waste into a non-polluting material. Instead of flushing waste away to be treated, which consumes energy and can lead to water pollution, it turns waste into compost that can be used as a soil amendment.
- The toilet uses a fan to maintain air flow, which not only helps in composting but also keeps the unit odour-free. The design ensures that smells are vented outside.
- Maintenance involves simple tasks like stirring the compost occasionally and emptying the solid waste container every few weeks or months, depending on usage. The liquid waste is separated and can be drained easily, reducing the frequency of emptying.

COMFORT



SPACE HEATER

KAG7371

This heater operates by circulating the heating fluid from the hot water system through its tubed heat exchanger. There is a choice of 2 "super quiet" fan speeds that have as much noise as a computer fan.

This unit will operate as long as the hot water circuit is functioning which can be programmed to come on at any time.



KIMBERLEY 2KW DIESEL AIR HEATER

KAG357R

Powerful 2kW diesel-powered air heater. Consumes minimal power & fuel. Remote display with stepless modulation control. Performs at high altitudes & with quiet operation.



DUAL LAYER FOAM LARGE DOUBLE MATTRESS

KAG

- Soft top layer for comfort
- Firm base for support
- Complete with zip-on cover
- The ultimate comfort for the minimum thickness mattress available



INNERSPRING LARGE DOUBLE MATTRESS

KAG

- Individual pocket springs to minimise movement when partner moves on mattress
- Multi-layer construction

COMFORT



REVERSE CYCLE ROOFTOP AIRCONDITIONER

KAG840

Ultimate efficiency: can run on batteries from inverter. Replenish power with solar.

- 3KW roof-top unit designed for maximum comfort.
- Bluetooth control for smartphone management.
- Operates with a powerful 3000-watt output for efficient cooling and heating.
- It's noted for its quiet operation, lightweight at 35kg, and comes with a 3-year warranty.



12V FAN WITH TIMER

KAG0461_KR

The perfect choice for sleeping in comfort.

Features:

- Low Power Consumption: Efficient with minimal battery drain.
- Silent Operation: Quiet enough for use while sleeping.
- 360° Airflow: Gimbal design allows air direction in any angle.
- Timer Settings: Auto-shutoff options conserve power and comfort.
- Compact Design: Folds flat when not in use, saving space.



POWERED FAN HATCH

KAG857

Provides excellent cooling of the vehicle by removing hot air.

A powered fan hatch in a motorhome offers:

- Ventilation: Efficiently removes moisture, heat, and odours.
- Cooling: Enhances air circulation, reducing the need for air conditioning.
- Light: Provides natural light, making the interior brighter.
- Convenience: Easy control with minimal effort for opening/closing.
- Safety: Reduces condensation, preventing mould growth.

COMFORT



MAGAZINE RACKS + SS DRINK HOLDER

KAG840

- Magazine Rack: Keeps reading materials organized and accessible.
- Drink Holder: Secures beverages preventing spills, especially on the move.

Together, they enhance organization, comfort, and convenience in limited space.



MAIN DOOR AND REAR DOOR INSECT SCREENS

KAG

- Allows fresh air to circulate while keeping bugs out, enhancing comfort & reduces the need for air conditioning
- Shield yourself from insects
- Provides an extra layer of privacy when doors are open.
- Easy access in and out of the motorhome without worrying about unwanted pests.



MAGNETIC CURTAINS ON REAR WINDOWS & CURTAIN IN CAB (KIT)

KAG

- Offers seclusion in camping spots or urban areas.
- Blocks sunlight for better sleep or cooler interiors.
- Helps keep the heat out, aiding in temperature control.
- Magnetic curtains are simple to install and adjust.
- Adds a cozy, home-like feel to the motorhome interior.
- Curtain in cab provides privacy from the front of the vehicle.

COMFORT



↑
COCKPIT THERMAL CURTAIN

↑
ENSUITE CURTAIN



ENSUITE CURTAIN

KAG

A lightweight, hand-stitched fabric attaches via press studs in the Kruiswagen's central area, creating a private "Ensuite" bathroom space for dressing after a shower.

It also doubles as a privacy screen between the bed and office areas, allowing one person to sleep while another works, and optimizes air conditioning by enclosing a smaller, efficient cooling zone.

COCKPIT THERMAL CURTAIN

KAG

Handcrafted thermal dark fabric, designed and sewn in-house, easily attaches to a curtain rail spanning the roof between the cockpit and living space.

- It provides a swift and simple way to create a private zone behind the cockpit.
- While on the road, it separates the living area from the cockpit, helping to maintain a cooler or warmer temperature in the cockpit as needed.
- This removable partition enhances the living area's segregation from the cockpit, improving comfort and ambiance for a more enjoyable living experience.



COMFORT



SEAT ORGANISER

KAG

Seat back organiser behind the passenger seat in the vehicle cabin.

- Enhances the motorhome by providing lightweight, compact storage to keep essentials organized.
- Attaches easily to seat, maximizing space in your living area.
- Durable design ensures reliability for camping and travel.



COMFORT ROTATING FRONT SEAT & OFFICE DESK

KAG

Front passenger seat rotates 180° to create an office area and use the separate multi-purpose desk!



COMFORT



CABIN STORAGE POUCH - LOWER

KAG

- A custom built mesh storage pouch that blends in well with the rest of the Kruiswagen build.
- This conveniently located pouch is a haven for nick knacks and bits and bobs whilst on the road



CABIN OVERHEAD STORAGE POUCHES

KAG

- Easy reach for drivers and passengers on the go.
- Uses otherwise unused space above seats for storage.
- Can store various items like clothes, electronics, or snacks.



CABIN OVERHEAD STORAGE SHELF

KAG

- Utilizes vertical space for storage, maximizing living area.
- Keeps items within easy reach while driving or parked.
- Helps keep essentials like maps, snacks, or electronics organized.
- Enhance the interior by providing a clean, streamlined look.

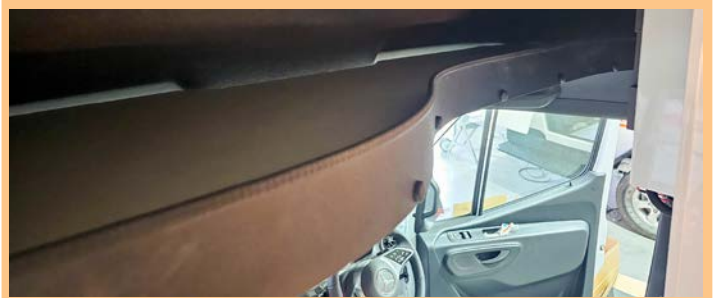

COMFORT



KARGO KEEPERS - PASSENGER DINNETTE SEAT

KAG

- Keeps items out of sight for a cleaner look.
- Utilizes space behind seats efficiently.
- Quick grab for essentials without moving from seating area.
- Can hold a variety of items from books to utensils.



KARGO KEEPERS - DINETTE FLOOR

KAG

- In-house designed and made, mesh panels with reinforced perimeters.
- Great for storing cargo on the floor between the dinette seats (x2 included).
- Easy to install/remove with quick velcro attachments.



KARGO POUCHES - DINETTE SEAT ENDS

KAG

- x2 storage pouches on the rear end of the dinette seats.
- In-house designed and made, mesh pockets with reinforced hems.

COOKING & KITCHEN



INSIDE: SOLID SURFACE (CORIAN™) BENCHTOP, HOT AND COLD WATER WITH STAINLESS SINK.

KAG

- Solid surfaces resist stains and are easy to clean.
- Enhances the interior look with a seamless, modern feel.
- Hot and cold water for comfortable cooking, cleaning, and personal hygiene.
- Adds a home-like feel, making extended living or travel more pleasant.



INSIDE: 12V FRIDGE WITH SMART COOLED COMPRESSOR, ELEVATED SPEED, ICE FREEZER, 130L

KAG

A 12V fridge in a motorhome offers:

- Energy Efficiency: Runs on the vehicle's battery, saving fuel.
- Space Saving: Compact design fits well in small spaces.
- Freshness: Keeps food and drinks cold, preserving perishables longer.



UPGRADE TO A LARGE 190L - ISOTHERM, DUAL DOOR - FRIDGE AND FREEZER -STORAGE BIN ABOVE

KAG

- Ample space for extended trips, reducing the need for frequent restocking.
- Keep a large amount of food and drinks cold, enhancing self-sufficiency.
- Suitable for those needing more storage for provisions.

COOKING & KITCHEN



SINGLE PLATE INDUCTION COOKTOP (Stand Alone - Portable)

KAG732INDUCTION

- Position this portable unit where you want it most. Great for small through-to-larger pots and pans.
- Three different wattage settings - 900, 1500 or 2000W.



SMART RV - DUAL PLATE INDUCTION COOKTOP (BUILT-IN)

KAG732_DI

- Smart RV Induction Cooktop offers 2 independent zones for cooking.
- Great for cooking with two pots/pans at once.
- Features child-lock, timer function and auto-sensing cut-off for safe and convenient cooking. Wattage settings up to 1800W.



DIESEL COOKTOP (BUILT-IN)

KAG732

- Easy to keep clean
- Doubles as preparation area when not used
- Economical and safe for remote travel
- No need for lighters or matches either - just push a button and you are ready to cook!

COOKING & KITCHEN



MICROWAVE OVEN

KAG825

- 23L Smart Inverter Microwave Oven for fast and efficient cooking and intuitive touch controls for ease of use.
- Highly-versatile, it lets you cook, warm, and defrost food without having to use a separate appliance.



WIRELESS BENCHTOP USB CHARGING

KAG

- Underbench wireless charging for smart phones and tablets
- Places under the benchtop for instant charging without cables



COOKING & KITCHEN



Enjoy cooking outside with the Cooks Kitchen - featuring your choice of slide out cooker, hot and cold water and stainless steel sink and preparation bench.

- Extends living and cooking area outdoors.
- Reduces clutter inside by cooking outdoors.
- Ventilation: Better air flow, keeping the interior cooler and free of cooking odours.



COOKING & KITCHEN



COOKS KITCHEN - 2 BURNER COOKER WITH GRILLER

KAG

A 2 burner cooker provides:

- Versatility: Cook multiple dishes simultaneously or use the griller for toasting and grilling.
- Convenience: Simplifies meal prep with varied cooking options.
- Outdoor Living: Keep your interior cooler and odour-free.



COOKS KITCHEN - WOK BURNER

KAG

A WOK burner provides:

- High Heat Cooking: Ideal for stir-frying, searing, and quick cooking.
- Versatility: Can handle a range of cooking styles from Asian to BBQ.
- Efficient Fuel Use: Uses LPG for high output with controlled flame.



COOKS KITCHEN - NINJA ELECTRIC BBQ

KAG

An electric BBQ provides:

- Versatility: Grills, air fries, and more, all in one appliance.
- Convenience: No need for charcoal or gas, just plug in and cook.



COOKING & KITCHEN



GALLEY KITCHEN - NO COOKER

KAG

- Stainless steel slide out kitchen with fold over preparation bench.
- Utensil compartments and cutlery drawer
- Stainless steel sink
- Hot and cold water

(Note: Image shows electric BBQ on preparation bench - this is not included and must be ordered separately)

POWER



Kruiswagen 48V Smart Power System

KAG

All NEW - SMART 48V Power Hub with Control Panel - HUB includes X-Stream fast charging 3000W AC charger, 3600W AC Pure Sinwave inverter, 70Amp DC Output at 13.6V, x2 Solar regulators 1600W max and 60amp DC/DC Charger (1000W).

Bluetooth and Wifi connected.

Also includes SMART Monitor for total power control.

2000Wh or 5000Wh SMART 48V Battery

KAG

Benefits:

- More power storage for extended off-grid trips.
- Quick recharge times, reducing downtime.
- Designed for long cycle life, reducing replacement frequency.
- Efficiency: High energy efficiency, optimizing power use.



POWER

HIGH PERFORMANCE SOLAR

InstaPower 48V 200W Solar Panel: The Ultimate Power Solution for Motorhomes

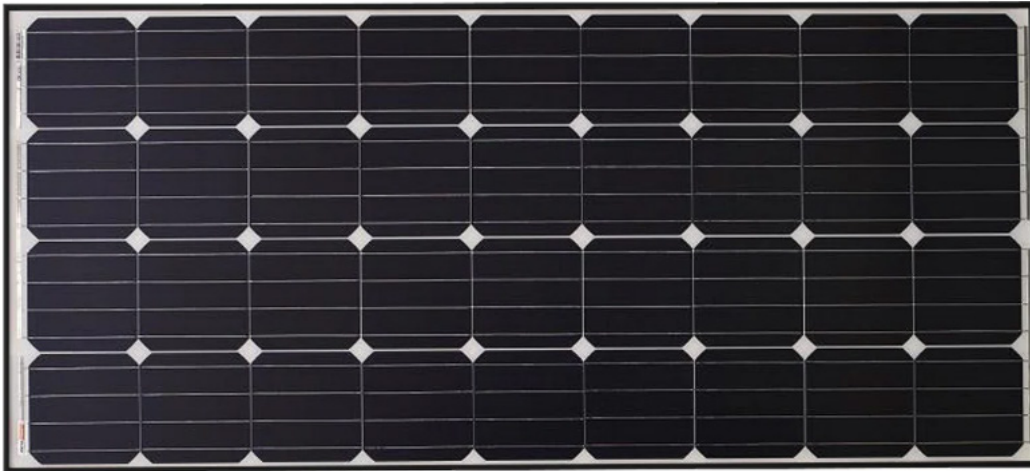

Elevate your motorhome experiences with the InstaPower 48V 200W Solar Panel. This panel is not just about power; it's about optimizing your energy needs on the move:

48V Design with 86V Open Circuit Voltage: The 48V design ensures that the panel operates at a higher efficiency, and the 86V open circuit voltage is crucial for 48V systems. This provides the necessary headroom to ensure maximum power generation, especially vital for maintaining consistent energy supply in varying weather conditions.

Importance of Proper Headroom: Having the correct open circuit voltage provides a buffer, ensuring that the panel's performance doesn't drop drastically under sub-optimal conditions. This headroom is essential for 48V systems to function efficiently and reliably.

Compatibility with MPPT Chargers: This solar panel can be seamlessly integrated with MPPT chargers for 48V systems. MPPT chargers optimize the power output from the solar panels, ensuring you harness every bit of energy from the sun, regardless of your system's voltage.

Benefits of Higher Panel Voltage: Utilizing a 48V panel reduces the current in the wiring from the roof to the MPPT, leading to less energy loss and more efficient power transfer. Moreover, using high voltage

Model	IP200M-65-1480-670
Maximum Power(W)	200
Optimum Power voltage(Vmp)	68.66
Optimum operating current(Imp)	2.91
Open circuit voltage(Voc)	80.26
Short circuit current(Isc)	2.96
Size of module(mm)	1480*670*35
Front glass thickness(mm)	3.2
Temperature range(C)	-40 to +85
Tolerance wattage(%)	0/+3%
Surface maximum load capacity(Pa)	2400
Allowable hail load	23m/s,7.53g
Frame	Anodized Aluminium Alloy
Weight per piece(kg)	11.5
Standard test conditions	AM1.5,1000W/m ² ,25 C (+/-2 C)
FF(%)	≥ 73.3

panels in parallel is superior to using 12V panels in series. This is because shading on one panel won't affect the performance of the others, ensuring consistent power generation.

High Efficiency and Shade Tolerance: Designed with high-efficiency mono cells, this panel delivers maximum power in a compact footprint. Its improved shade tolerance ensures consistent power generation even when parts of the panel are shaded.

Trusted Brand: InstaPower is synonymous with quality. Each panel is thoroughly tested and backed by an industry-leading 5-year warranty. You can rely on its performance and durability.

POWER

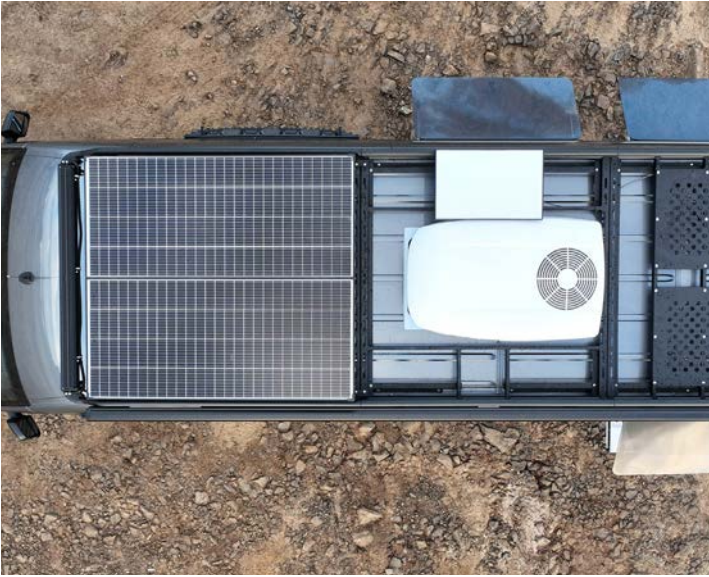

400W ROOF MOUNT SOLAR

KAG

Roof-mounted solar panels on a motorhome provide:

- Space Efficiency: Utilize unused roof space for power generation.
- Increased Autonomy: More solar exposure leads to greater energy independence.
- Aesthetic Integration: Sleek design blends with the motorhome's profile.
- Reduced Fuel Costs: Less reliance on generators or shore power.
- Eco-Friendly: Lower carbon footprint while travelling.



800W ROOF MOUNT SOLAR

KAG

Add an additional 2x 200W solar panels mounted on flyover brackets so you can keep the airconditioner.



400W ROOF MOUNT SOLAR - INLINE PASSENGER SIDE

KAG

- Allows for long objects to be carried on roof rack - surfboards, SUPs etc.
- Flyover bracket design allows full use of roof hatch and airconditioner.



POWER

ALTERNATIVE SOLAR LAYOUTS



800W Roof Mount Solar - PS Inline Panels

- Add 2x 200W solar panels along the roof rack on the passenger side of the motorhome.
- Elevated flyover panel design allows airconditioner to still be fitted and maximum solar performance with no panel shading.
- Allows space for surfboards, watercraft or other long items needing rooftop storage.
- Secure your precious boards up top away from prying eyes.
- Keep your rear door free for other storage options.

800W Roof Mount Solar - DS Inline Panels

- Add 2x 200W solar panels along the roof rack on the driver side of the motorhome.



POWER

PORTABLE SOLAR KIT



EcoFlow NextGen 220W Bifacial Portable Solar Panel

- Collect up to 25% more energy with a two-in-one bifacial design
- Up to 25% conversion efficiency rate
- 30-60° adjustable angle bracket and integrated solar angle guide
- Durable tempered glass & ETFE coating; built to last
- Lightweight and compact; ultra portable
- IP68 rating protects against water and dust

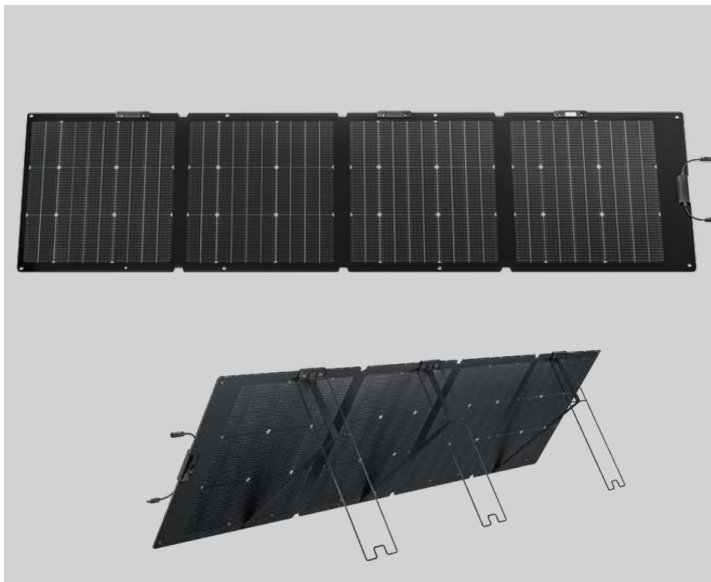

220W PORTABLE SOLAR KIT

KAG3986

The EcoFlow NextGen 220W Bifacial Portable Solar Panel Kit for an offgrid motorhome provides:

- Increased Energy Capture: Bifacial design absorbs light from both sides, up to 25% more energy.
- Portability: Lightweight and foldable for easy storage and transport.
- Durability: IP68 rating ensures resistance to water and dust.
- Efficiency: Up to 25% conversion rate for faster charging.

POWER



DUAL READING LED STALK LIGHTS AT BED HEAD

KAG

- LED reading lights mounted on walls near the bedhead. Individually switched for reading while your partner sleeps. Adjustable direction.



OUTSIDE - 2 X EXTERIOR ORANGE/WHITE LED LIGHT.

KAG0372

- A powerful weatherproof exterior 2-in-1 dual LED light with cool white for campsite lighting and orange to attract less insects. Switched individually for single or combination operation. Mounted high on passenger side under awning.



OUTSIDE - KITCHEN LED LIGHT - DUAL COLOUR

KAG0371

- A powerful weatherproof exterior 2-in-1 dual LED light with cool white for cooking and orange to attract less insects. Switched individually for single or combination operation.



POWER

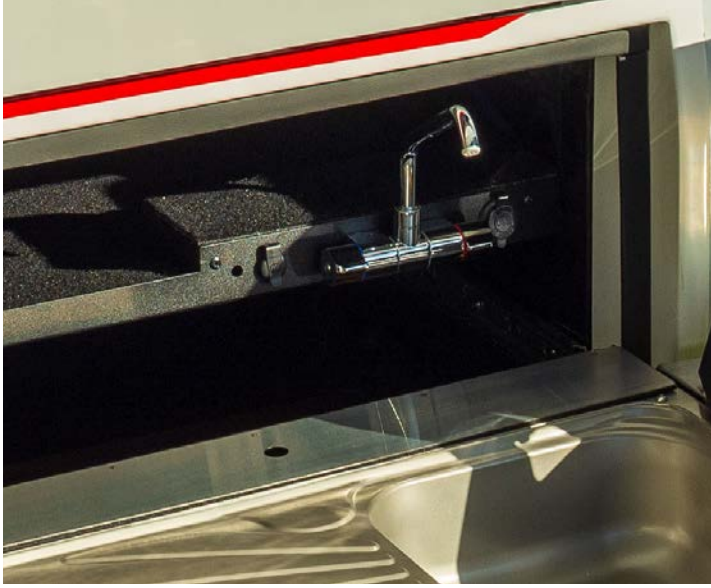

OUTSIDE - KITCHEN USB AND 12V OUTLET

KAG

- Easy access to power for devices without entering the motorhome.
- Charge phones, power lights, or run small appliances directly.
- Use gadgets outdoors for cooking, entertainment, or work.
- No need for additional power sources or extension cords.



INSIDE - LED INTERIOR LIGHTING PACKAGE

KAG

- x1 ensuite
- x1 under Overhead (Stalk)
- x1 door entry (stalk)
- strip dual lighting on side of van above windows
- Backlighting under overhead cupboards

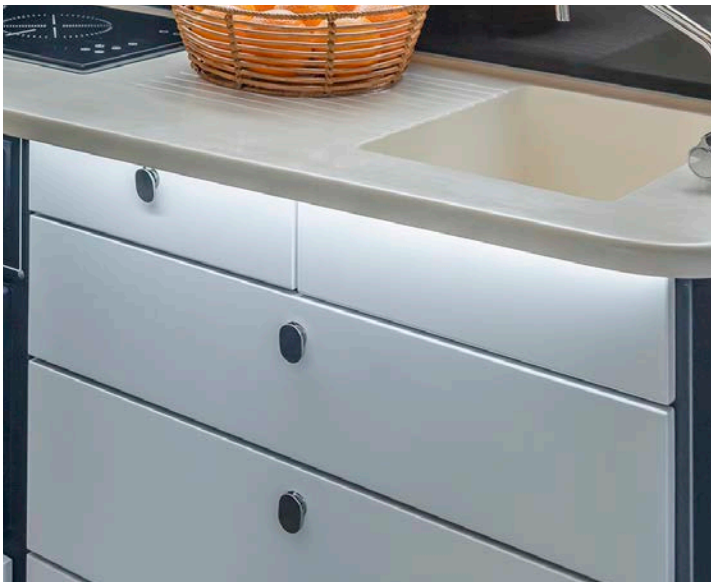

UNDERBENCH LED'S - UNDERSIDE OF KITCHEN BENCHES, BOTH SIDES

KAG

- Cool white LED strip lighting mounted under the kitchen bench provides helpful lighting for drawers and creates good ambient 'mood' lighting when relaxing.

MISCELLANEOUS



BED WALLS & ROOF LINED WITH SOFT FABRIC OR PERFORATED AUTOMOTIVE HEAD LINER

KAG

Lining a motorhome's ceiling and walls with soft fabric offers:

- **Acoustic Insulation:** Reduces noise from both inside and outside.
- **Thermal Comfort:** Acts as an additional layer for insulation against temperature extremes.
- **Aesthetic Enhancement:** Creates a more inviting, home-like atmosphere.
- **Condensation Control:** Helps in managing moisture, preventing mould growth.



DROP DOWN COMPOSITE LARGE DOUBLE BED ON KK POWERGLIDE LIFT SYSTEM, ONE TOUCH LIFT AND LOWER WITH MANUAL BACK-UP SYSTEM.

KAG

A loft bed in a motorhome offers:

- **Space Efficiency:** Maximizes space to create a full size large 4 seat dinette space underneath.
- **Privacy:** Creates a separate sleeping space that is hidden from site during the day.
- **Comfort:** Enjoy a once-piece double size bed, ready to go as soon as it is lowered in place.



MISCELLANEOUS



VEGAN OR AUTHENTIC LEATHER SEATING WITH DUAL HIDES

KAG

Leather seating in an offroad motorhome provides:

- Durability: Resistant to wear and tear.
- Ease of Cleaning: Simple to wipe down, vital in dusty or muddy conditions.
- Temperature Regulation: Naturally cools in summer, warms in winter.
- Aesthetic Appeal: Adds a touch of luxury and comfort.

Customise the upholstery stitching patterns to suit your style and tastes.

Choose from the following:

- Fluted, Diamond straight or Diamond contour.



Fluted stitching pattern



Diamond contour stitching pattern



Diamond straight stitching pattern



Diamond straight stitching pattern (dual hides)

MISCELLANEOUS

KRUISWAGEN INTERIOR FINISH - "NATURAL"



KRUISWAGEN INTERIOR FINISH - "CONTEMPORARY"



MISCELLANEOUS

KRUISWAGEN INTERIOR FINISH - "NATURAL" WITH BLACK BENCHTOPS



MISCELLANEOUS



INTERNAL FLOOR UPGRADE - TO COMMERCIAL GRADE IMPORTED VINYL FLOOR PLANKS

KAG

Vinyl floor planks in an offroad motorhome offer:

- Water Resistance: Ideal for wet conditions or spills.
- Durability: Withstands heavy use and movement.
- Easy Maintenance: Easy to clean, no need for special treatments.
- Comfort: Offers warmth underfoot, insulation against cold.



KRUISWAGEN TIMBER DRAWER AND DOOR FRONTS

KAG

Bamboo timber drawer fronts in an offroad motorhome provide:

- Sustainability: Bamboo is fast-growing, eco-friendly.
- Strength: Durable and resistant to wear.
- Aesthetic: Natural beauty adds warmth to interiors.
- Moisture Resistance: Better than some woods, though care is needed in humid conditions.



MISCELLANEOUS



BLUETOOTH SOUNDBAR

KAG

- Versatile Connectivity: Works with smartphones, USB, and MP3 players.
- Wireless Freedom: Stream audio without cables, perfect for limited space.
- Remote Control: Adjust settings from anywhere in the vehicle.
- Energy Efficiency: Low power use, ideal for off-grid living.
- Enhanced Audio: Improves sound experience in a confined space.



PREMIUM ALL-IN-ONE PANEL STEREO

KAG

Combines all the elements required for excellent audio reproduction inside a single perfectly tuned enclosure. Enjoy flexibility in audio control options with Bluetooth audio streaming, AM/FM radio, USB and AUX audio connections available.

- All-in-one system saves space with integrated speakers.
- DSP technology ensures superior sound quality.
- Versatile Control: Fusion-Link for smartphone or Garmin watch control.



28" SMART LED TV + MOUNTING BRACKETS

KAG

Includes:

- 28" SMART LED TV, Swivel Knuckle and Padded Bag Package

A 28" LED TV in an offgrid motorhome provides:

- Fits small space without overwhelming the area.
- Energy Efficiency: LED technology conserves power, vital for off-grid.
- Portability: Light and easy to mount or move.
- Entertainment: Offers a range of viewing options.



CEL-FI GO FOR TELSTRA

KAG

The Telstra CEL-FI GO in an offgrid motorhome offers:

- Signal Boosting: Increases weak signal strength for better connectivity.
- Voice and Data: Enhances both call quality and internet speed.
- Coverage: Provides coverage where there's minimal or no service

Starlink Portable Internet System



Kimberley Kampers offer a custom bag to suit the Starlink RV Portable Satellite Internet kit. The Starlink RV Kit is supplied in a cardboard box which is protected by the Kimberley Starlink Storage Bag.

The supplied box does a good job of accommodating the kit, but is prone to water damage and is awkward to handle. Our water resistant canvas bag will keep it dry when you are setting up on a damp surface.

Generous webbing handles are stitched into the side and make it easy to handle and store this kit as you use it at home and off the road.

Starlink RV Ready

KAG

Add your own Starlink kit for exceptional coverage and speed all over the country.

Features:

- water-resistant canvas bag
- heavy duty YKK zippered top flap for easy opening
- webbing handle - fully stitched to sides



The discrete nature of the bag also disguises the valuable item inside (the box features bold Starlink branding which may attract unwanted attention from would-be thieves).

(This Option is for the Storage Bag only - Starlink RV System is to be supplied by customer).

MISCELLANEOUS

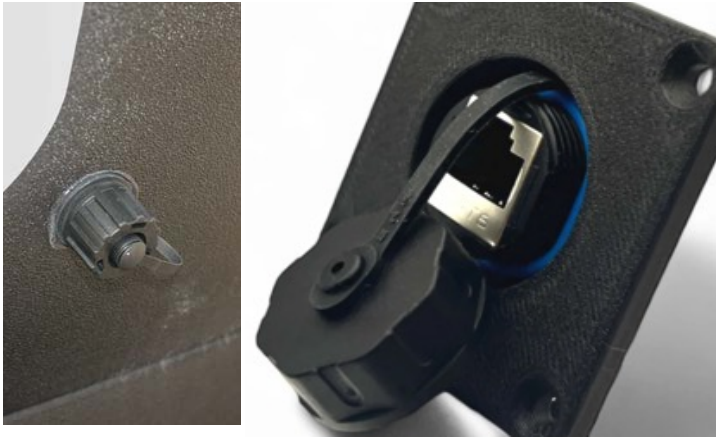

STARLINK READY - GEN2/3

KAG

- 3D printed Cat6 Data cable waterproof connection from internal to external connections
- Conveniently located 240V AC plug to run the modem off the inverter



STARLINK READY - MINI

KAG

- 3D printed 24V waterproof connection via 12V step up converter to 24V.
- The higher voltage provides a cleaner and more powerful power source to run the modem and dish as a stand alone operation.
- Increase the efficiency of power in running the mini.



STARLINK MOUNTED - GEN 2/3

KAG

- Custom powder coated alloy housing for the satellite dish to be permanently mounted on the roof of the Kruiswagen expedition rack
- Internally roughed in data cables to the Starlink modem from the roof to the power dash panel
- Dedicated 240V plug to run the modem off the Inverter or shore power
- Starlink Hardware supplied by customer

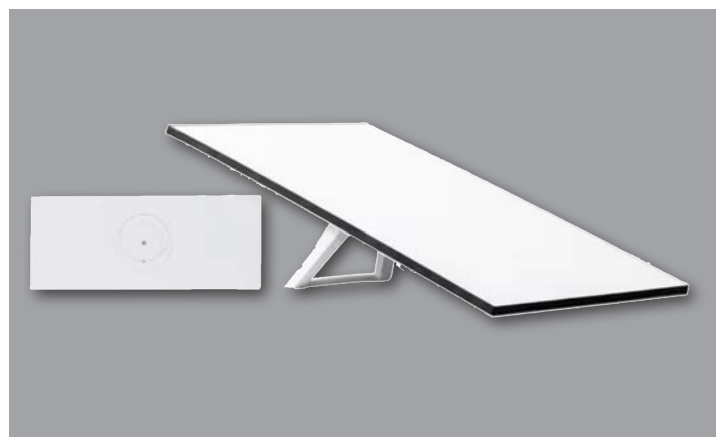

STARLINK - GEN 3 KIT

KAG

- KK can source the Starlink Hardware and have this fitted for your convenience on delivery.
- Hardware is charged out at cost plus handling and ordering fee.



©Kimberley Kampers 2026

Photos in this brochure may show models with optional equipment. There may also be unintentional errors in dimensions and details of options. Please consult your dealer before committing to purchase. Our thanks to all the Kimberley owners and our dealers who have contributed their ideas and feedback for our Models.

WARNING All materials in this publication are ©2025 Kimberley Kampers Manufacturing Pty Ltd. ACN 089659370. All models, concepts and designs shown herein are the intellectual property of Kimberley Kampers Manufacturing Pty Ltd. and subject to copyright design and trademark protection. Any unauthorised copying or use of this brochure is expressly prohibited.

KIMBERLEY KAMPERS

Ballina NSW 2478

sales@kkhq.com.au

+61(02) 6686 7344

kimberleykampers.com.au



KIMBERLEY KAMPERS

KING OF THE OFF ROAD™

www.kimberleykampers.com.au